

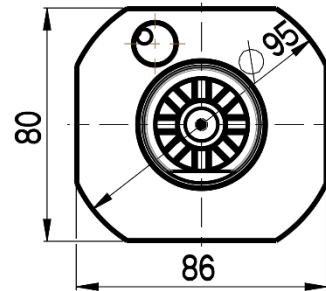

STRAIGHT LIVE TOOL HOLDER

VDI 40 / TOEM 200

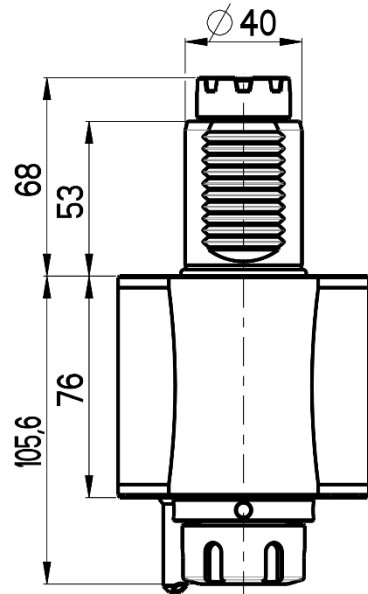
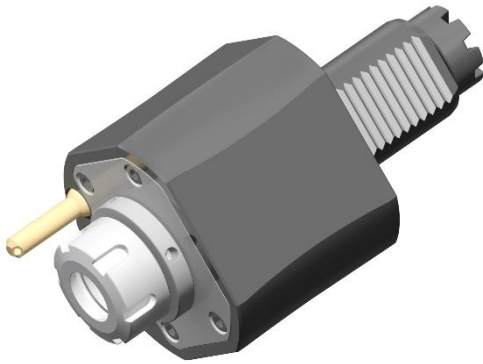

RGX1-40/141-25/1

Max. speed: 6000 rpm

Max. torque: 50 Nm

Collet: ER25

Direction of rotation:

Ratio: 1:1

Cooling: external (internal cooling available)

Accessories

Nut : Clamping wrench type E 25



Spindle: Hook wrench DIN 1810B 45-50