

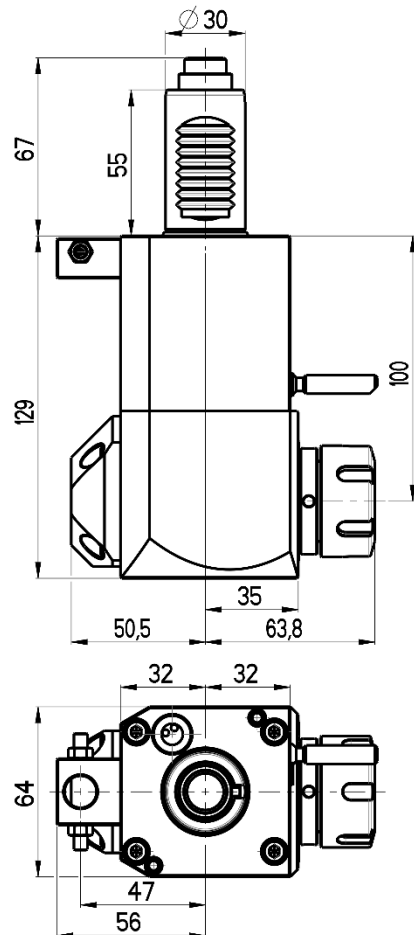

# ANGULAR LIVE TOOL HOLDER

VDI 30 / DIN 5480

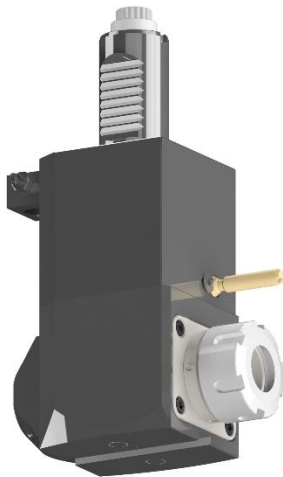

**RGX1-30/231-25/2.1-100**

**Max. speed:** 6000 rpm

**Max. torque:** 28 Nm

**Collet:** ER25

**Direction of rotation:**

**Ratio:** 1:1

**Cooling:** external & internal

**Max. pressure:** 20 bar

## Accessories

**Nut :** Clamping wrench type E 25

**Spindle:** Hook wrench DIN 1810B 40-42

