

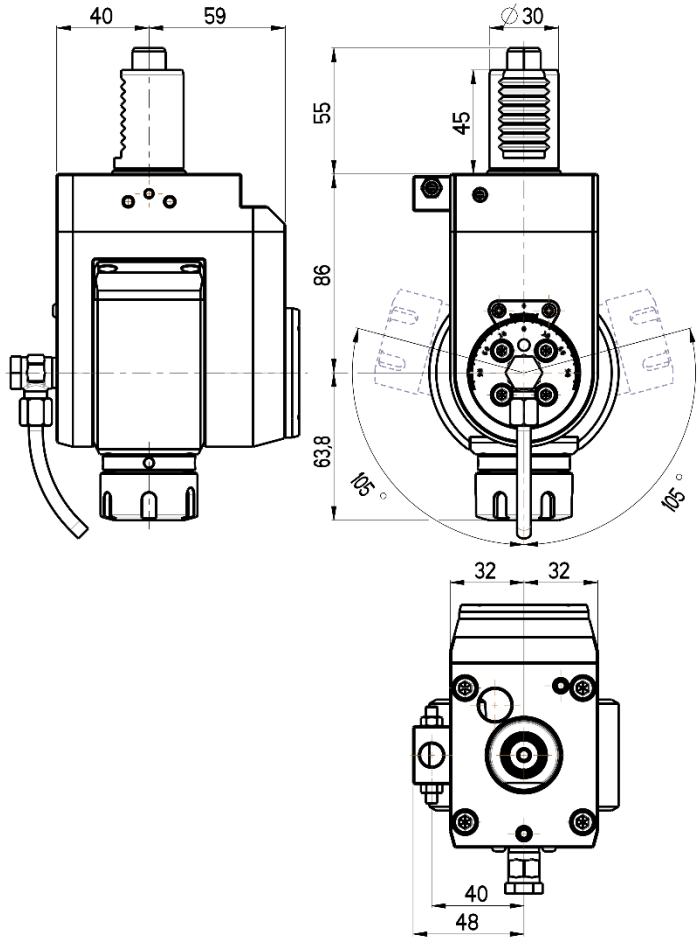

# VARIABLE ANGLE LIVE TOOL HOLDER

VDI 30 / DIN 5482

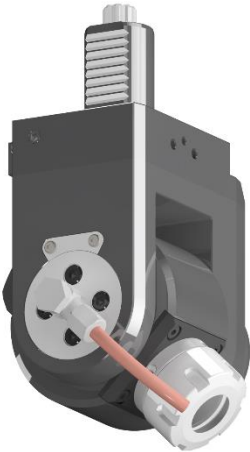

**RGX1-30/511-25/2**

**Max. speed:** 6000 rpm

**Max. torque:** 16 Nm

**Collet:** ER25

**Direction of rotation:**

**Ratio:** 1:1

**Cooling:** external & internal

**Max. pressure:** 20 bar

## Accessories

**Nut :** Clamping wrench type E 25



**Spindle:** Hook wrench DIN 1810B 40-42

