

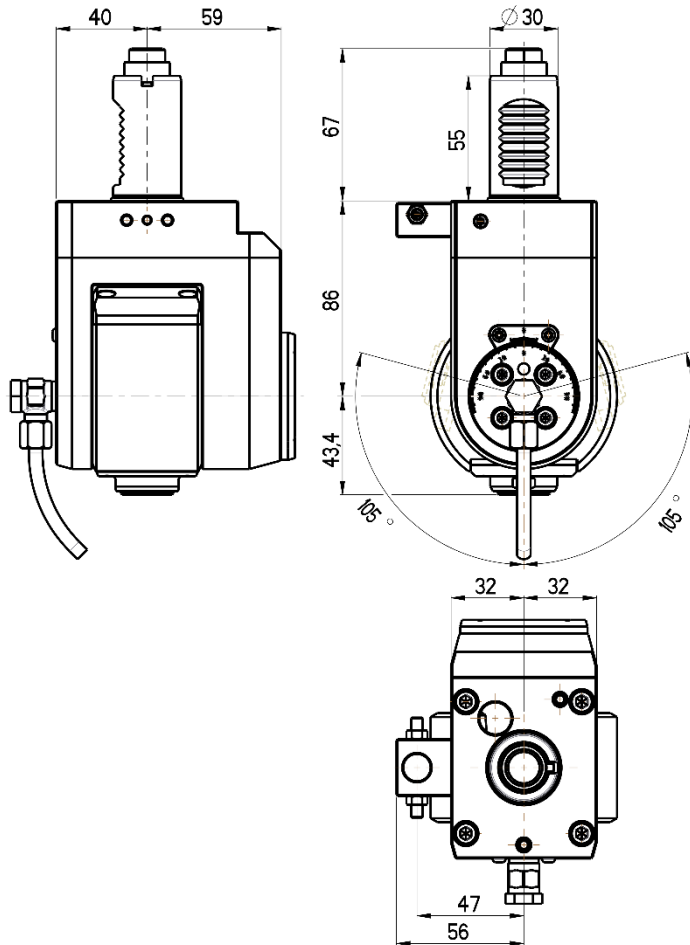

# VARIABLE ANGLE LIVE TOOL HOLDER

VDI 30 / DIN 5480

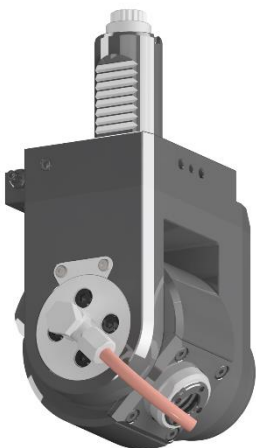

**RGX1-30/531-16/2**

**Max. speed:** 6000 rpm

**Max. torque:** 16 Nm

**Collet:** ER16

**Direction of rotation:** ↻ ↻

**Ratio:** 1:1

**Cooling:** external & internal

**Max. pressure:** 20 bar

## Accessories

**Nut:** Caliper pin wrench

**Spindle:** Spanner 28