

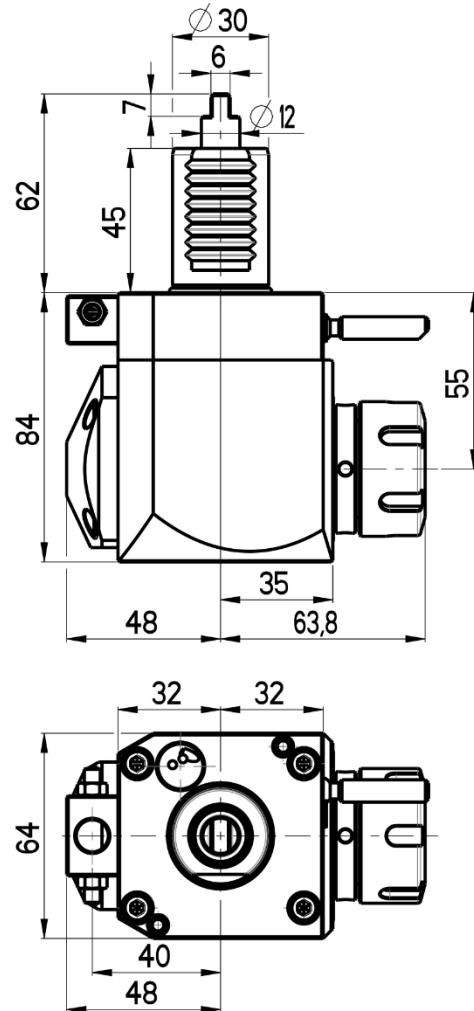

ANGULAR LIVE TOOL HOLDER

VDI 30 / DIN 1809

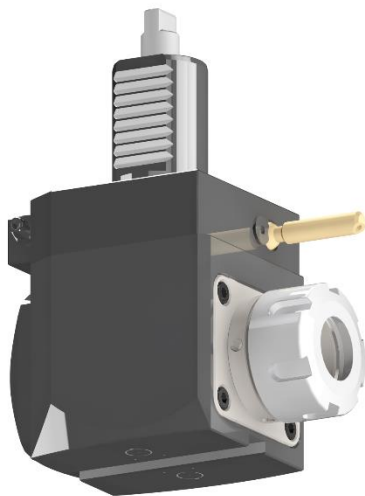

RGX1-30/221-25/1.1-55

Max. speed: 6000 rpm

Max. torque: 28 Nm

Collet: ER25

Direction of rotation:

Ratio: 1:1

Cooling: external (internal cooling available)

Accessories

Nut : Clamping wrench type E 25

Spindle: Hook wrench DIN 1810B 40-42

