

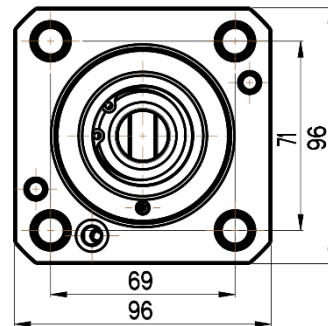

STRAIGHT LIVE TOOL HOLDER

NAKAMURA-TOME

BMT 65 TURRET

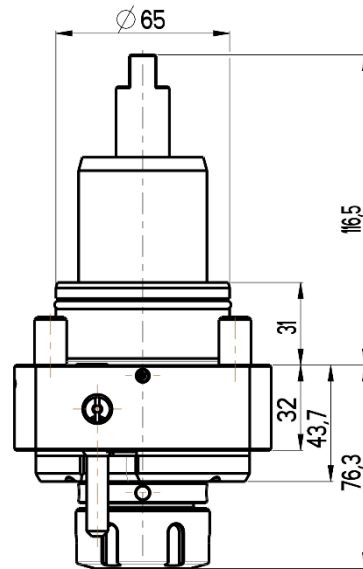

RGX2-65/101-32/2(NT)

Max. speed: 6000 rpm

Max. torque: 70 Nm

Collet: ER32

Direction of rotation:

Ratio: 1:1

Cooling: external & internal

Max. pressure: 20 bar

Accessories

Nut : Clamping wrench type E 32



Spindle: Hook wrench DIN 1810B 45-50

