

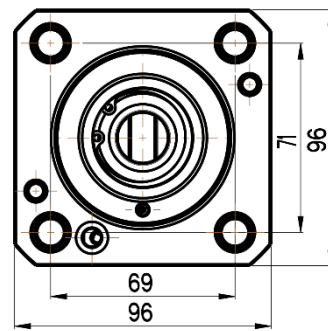

# STRAIGHT LIVE TOOL HOLDER

## NAKAMURA-TOME

### BMT 65 TURRET

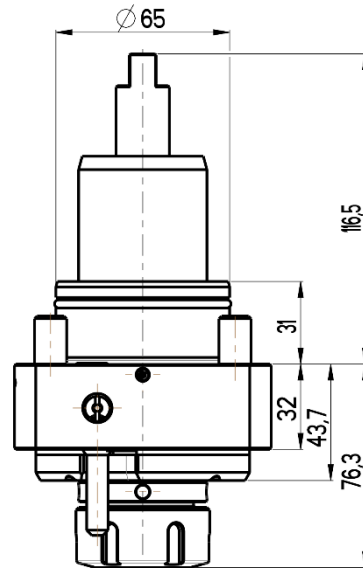

**RGX2-65/101-32/1(NT)**

**Max. speed:** 6000 rpm

**Max. torque:** 70 Nm

**Collet:** ER32

**Direction of rotation:** 

**Ratio:** 1:1

**Cooling:** external (internal cooling available)

#### Accessories

**Nut :** Clamping wrench type E 32

**Spindle:** Hook wrench DIN 1810B 45-50

