

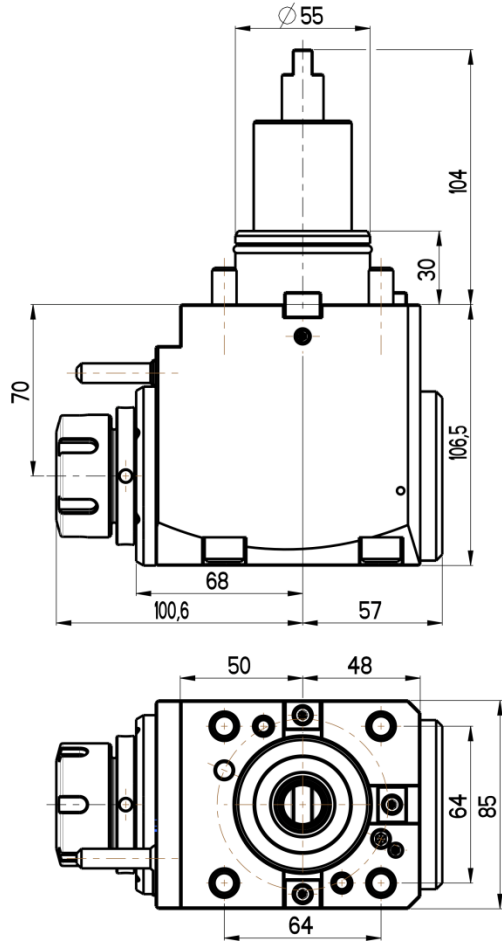

ANGULAR LIVE TOOL HOLDER

DOOSAN, Victor. Hwacheon

BMT 55 TURRET

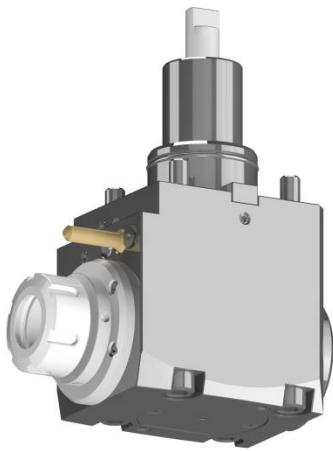

RGX2-55/201-32/2.3-70(DO)

Max. speed: 6000 rpm

Max. torque: 50 Nm

Collet: ER32

Direction of rotation:

Ratio: 1:1

Cooling: external & internal

Max. pressure: 20 bar

Accessories

Nut : Clamping wrench type E 32

Spindle: Hook wrench DIN 1810B 52-55

