

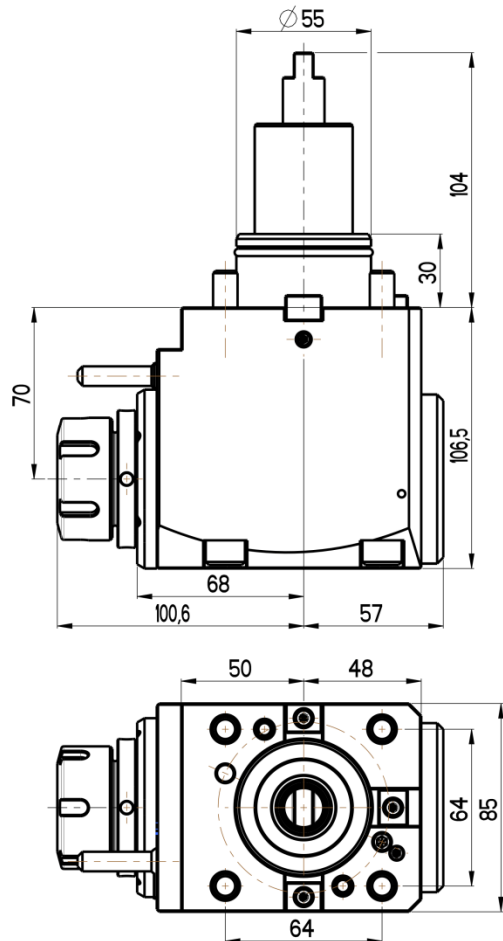

ANGULAR LIVE TOOL HOLDER

DOOSAN, Victor. Hwacheon

BMT 55 TURRET

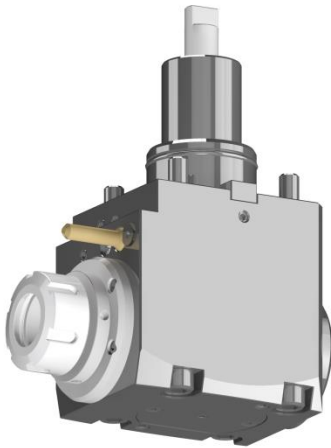

RGX2-55/201-32/1.3-70(DO)

Max. speed: 6000 rpm

Max. torque: 50 Nm

Collet: ER32

Direction of rotation: 

Ratio: 1:1

Cooling: external (internal cooling available)

Accessories

Nut : Clamping wrench type E 32

Spindle: Hook wrench DIN 1810B 52-55

