

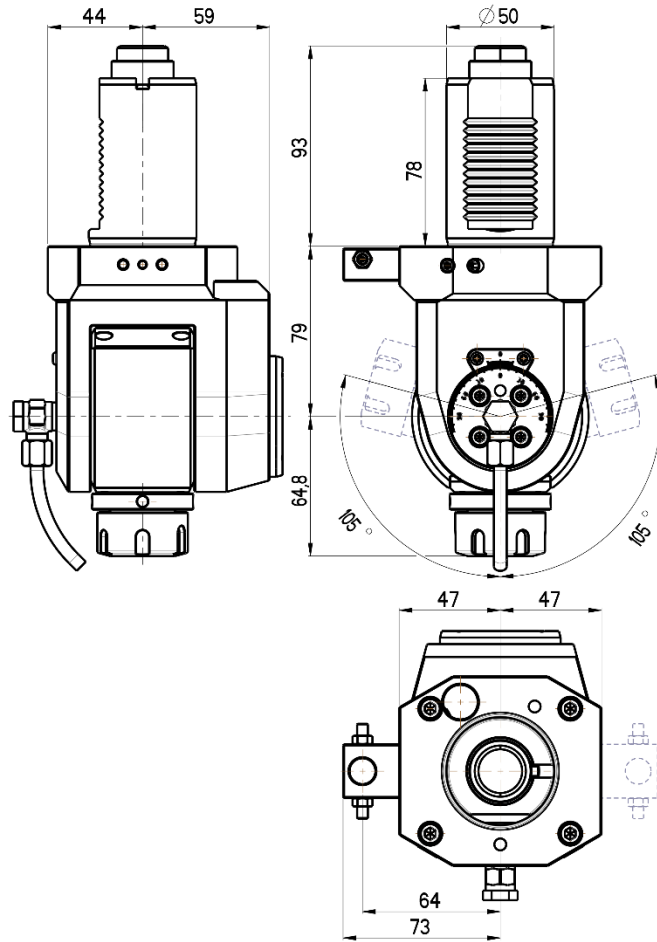

VARIABLE ANGLE LIVE TOOL HOLDER VDI 50 / DIN 5480



RGX1-50/531-25/1

Max. speed: 6000 rpm

Max. torque: 16 Nm

Collet: ER25

Direction of rotation: 

Ratio: 1:1

Cooling: external (internal cooling available)

Accessories

Nut : Clamping wrench type E 25



Spindle: Hook wrench DIN 1810B 40-42

