

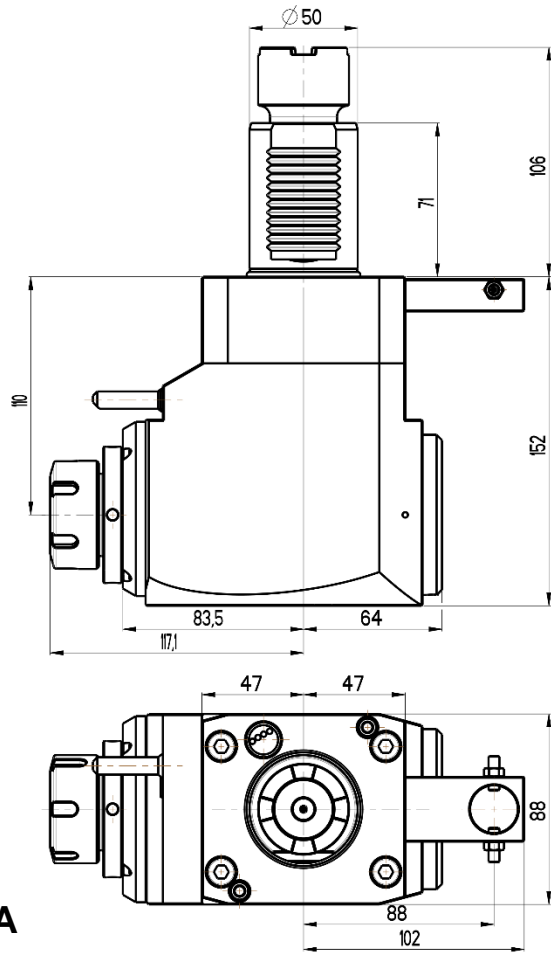

ANGULAR LIVE TOOL HOLDER

VDI 50 / STEPPED

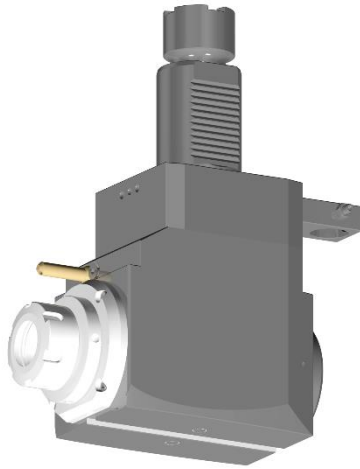

RGX1-50/251-32/2.2-110JA

Max. speed: 6000 rpm

Max. torque: 80 Nm

Collet: ER32

Direction of rotation:

Ratio: 1:1

Cooling: external & internal

Max. pressure: 20 bar

Accessories

Nut : Clamping wrench type E 32

Spindle: Hook wrench DIN 1810B 58-62

