

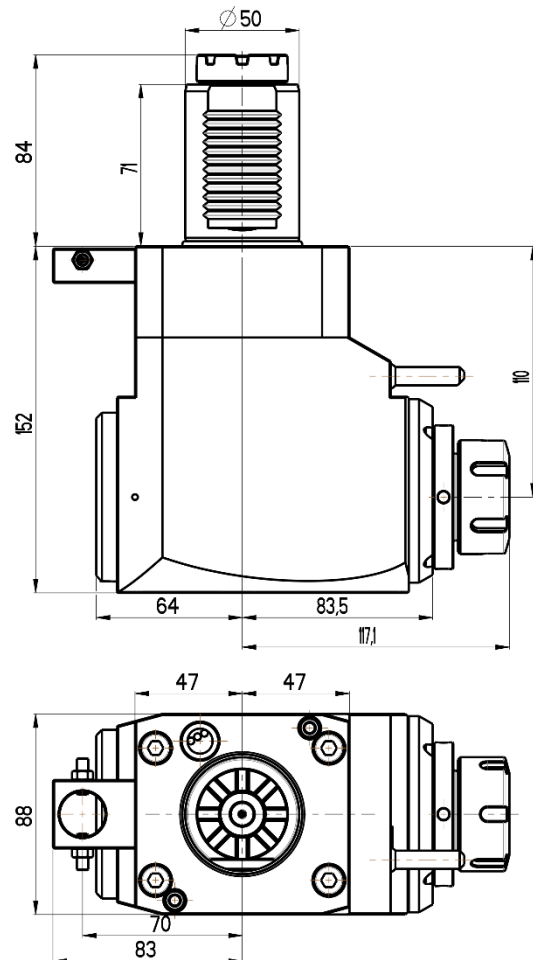

## ANGULAR LIVE TOOL HOLDER

VDI 50 / TOEM 250

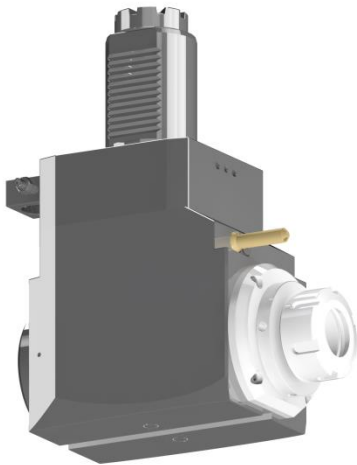

**RGX1-50/241-32/1.1-110**

**Max. speed:** 6000 rpm

**Max. torque:** 80 Nm

**Collet:** ER32

**Direction of rotation:**

**Ratio:** 1:1

**Cooling:** external (internal cooling available)

### Accessories

**Nut :** Clamping wrench type E 32

**Spindle:** Hook wrench DIN 1810B 58-62

