

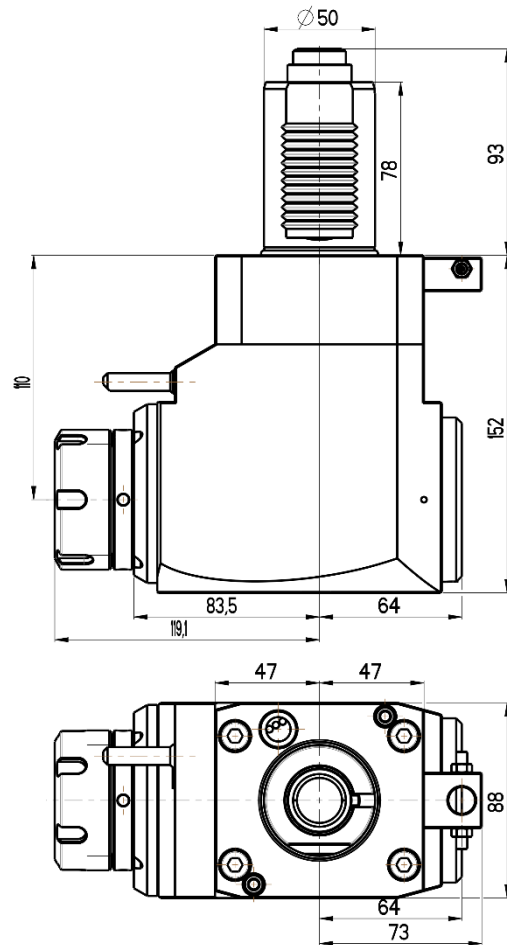

# ANGULAR LIVE TOOL HOLDER

VDI 50 / DIN 5480

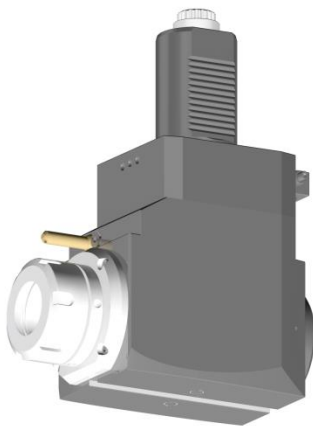

**RGX1-50/231-40/2.2-110**

**Max. speed:** 6000 rpm

**Max. torque:** 80 Nm

**Collet:** ER40

**Direction of rotation:**

**Ratio:** 1:1

**Cooling:** external & internal

**Max. pressure:** 20 bar

## Accessories

**Nut :** Clamping wrench type E 40

**Spindle:** Hook wrench DIN 1810B 58-62

