

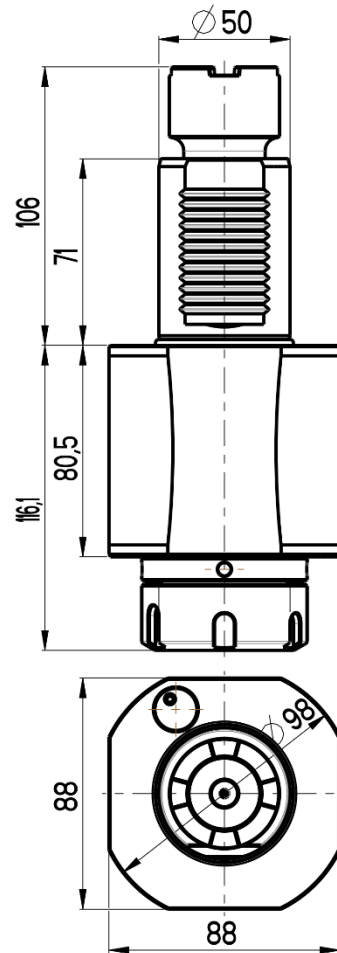

STRAIGHT LIVE TOOL HOLDER

VDI 50 / STEPPED



RGX1-50/151-40/2JA

Max. speed: 6000 rpm

Max. torque: 80 Nm

Collet: ER40

Direction of rotation: ↻ ↻

Ratio: 1:1

Cooling: external & internal

Max. pressure: 20 bar

Accessories

Nut : Clamping wrench type E 40

Spindle: Hook wrench DIN 1810B 58-62

