

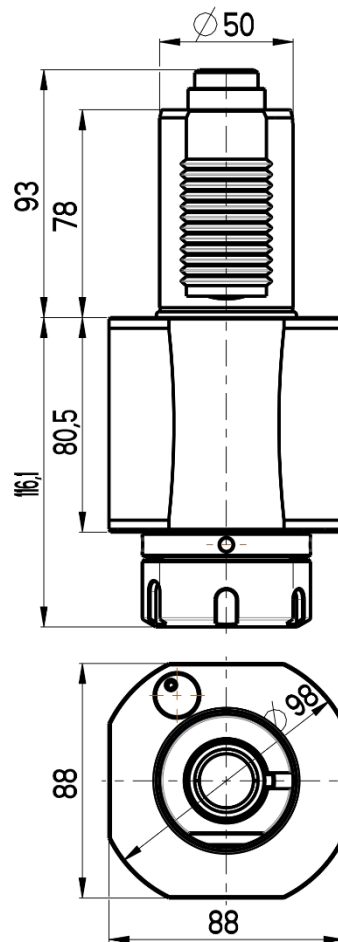

# STRAIGHT LIVE TOOL HOLDER

VDI 50 / DIN 5480

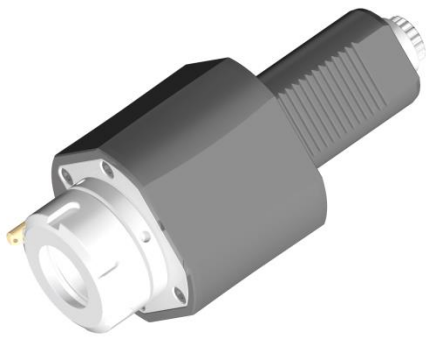

**RGX1-50/131-40/1**

**Max. speed:** 6000 rpm

**Max. torque:** 80 Nm

**Collet:** ER40

**Direction of rotation:**

**Ratio:** 1:1

**Cooling:** external (internal cooling available)

### Accessories

**Nut :** Clamping wrench type E 40



**Spindle:** Hook wrench DIN 1810B 58-62

