

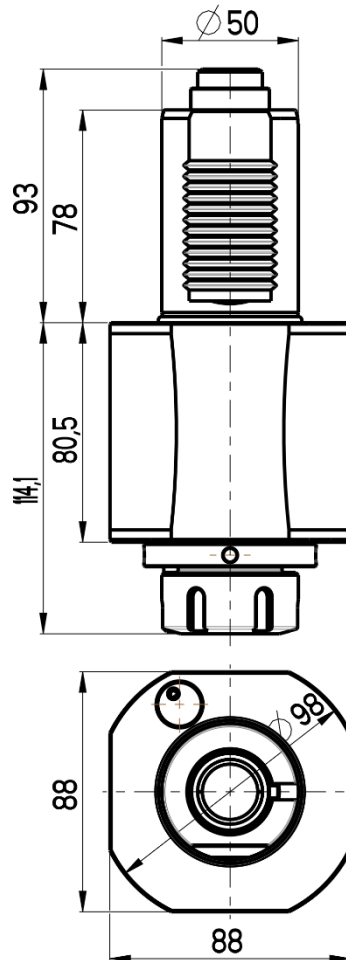

STRAIGHT LIVE TOOL HOLDER

VDI 50 / DIN 5480

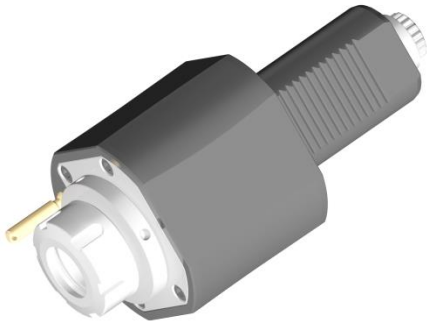

RGX1-50/131-32/1

Max. speed: 6000 rpm

Max. torque: 80 Nm

Collet: ER32

Direction of rotation:

Ratio: 1:1

Cooling: external (internal cooling available)

Accessories

Nut : Clamping wrench type E 32



Spindle: Hook wrench DIN 1810B 58-62