

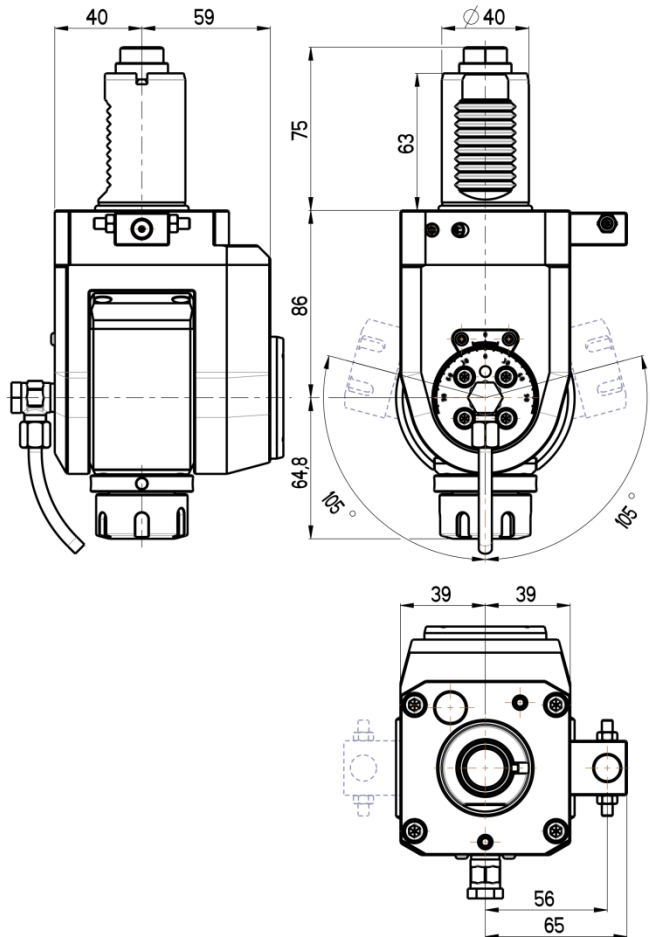

VARIABLE ANGLE LIVE TOOL HOLDER VDI 40 / DIN 5480

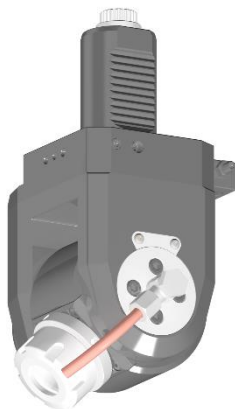

RGX1-40/531-25/2.2

Max. speed: 6000 rpm

Max. torque: 16 Nm

Collet: ER25

Direction of rotation: ↻ ↻

Ratio: 1:1

Cooling: external & internal

Max. pressure: 20 bar

Accessories

Nut : Clamping wrench type E 25



Spindle: Hook wrench DIN 1810B 40-42

