

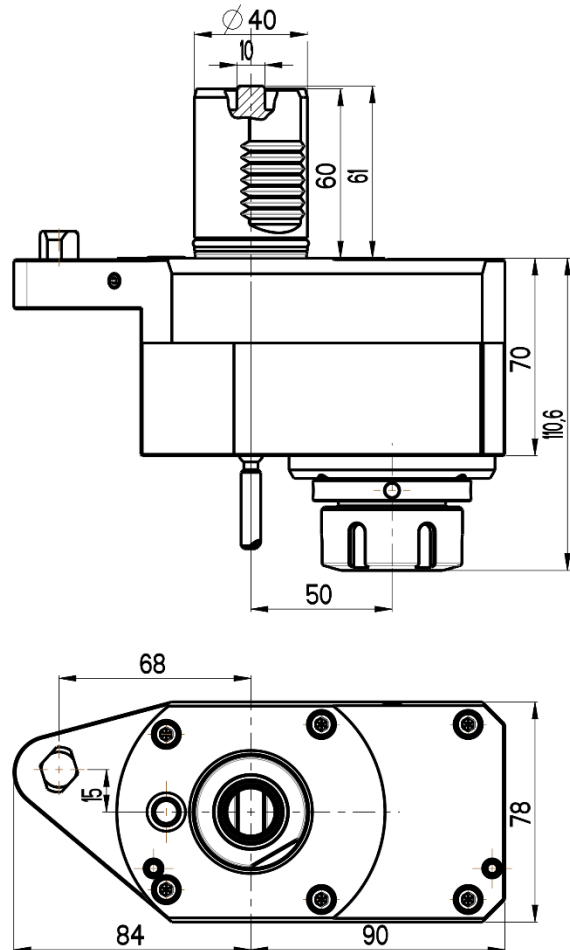

OFFSET STRAIGHT LIVE TOOL HOLDER

MAZAK QTN100/150

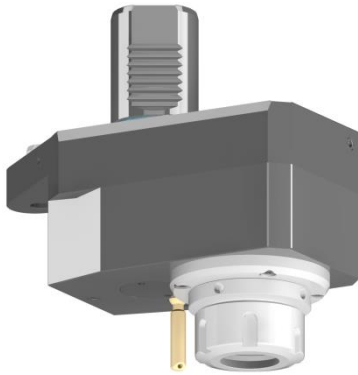

RGX1-40/321-32/2.1-50MZ1(2:1)

Max. speed: 3000 rpm

Max. torque: 80 Nm

Collet: ER32

Direction of rotation: ↻ ↻

Ratio: 2:1

Cooling: external & internal

Max. pressure: 20 bar

Accessories

Nut : Clamping wrench type E 32

Spindle: Hook wrench DIN 1810B 52-55

