

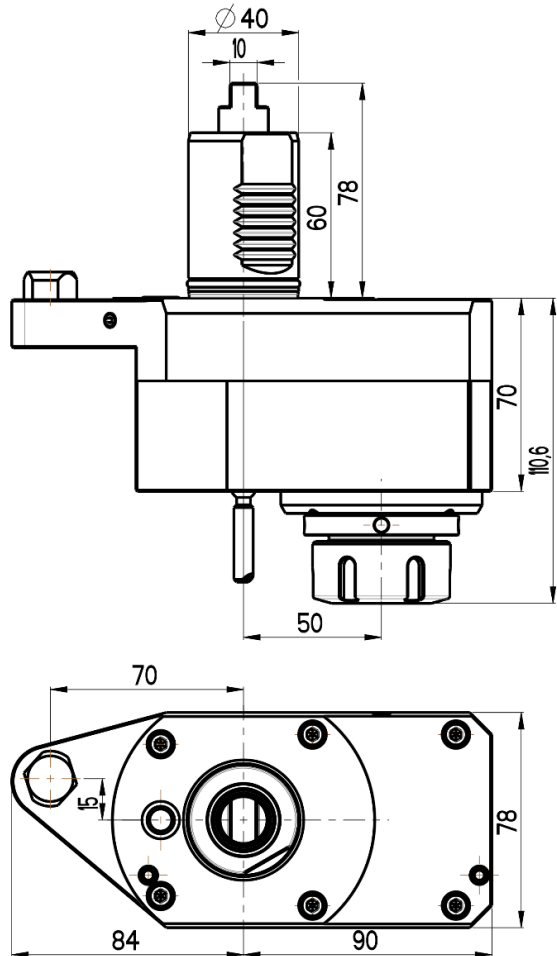

**OFFSET STRAIGHT
LIVE TOOL HOLDER
MAZAK QTN200/250**

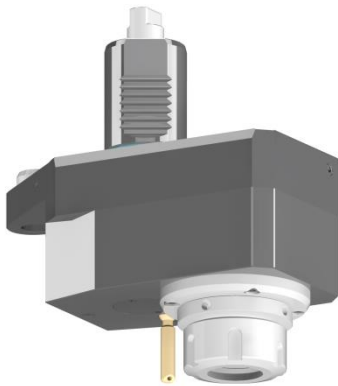

RGX1-40/321-32/1.1-50MZ2

Max. speed: 6000 rpm

Max. torque: 50 Nm

Collet: ER32

Direction of rotation:

Ratio: 1:1

Cooling: external (internal cooling available)

Accessories

Nut : Clamping wrench type E 32



Spindle: Hook wrench DIN 1810B 52-55

