

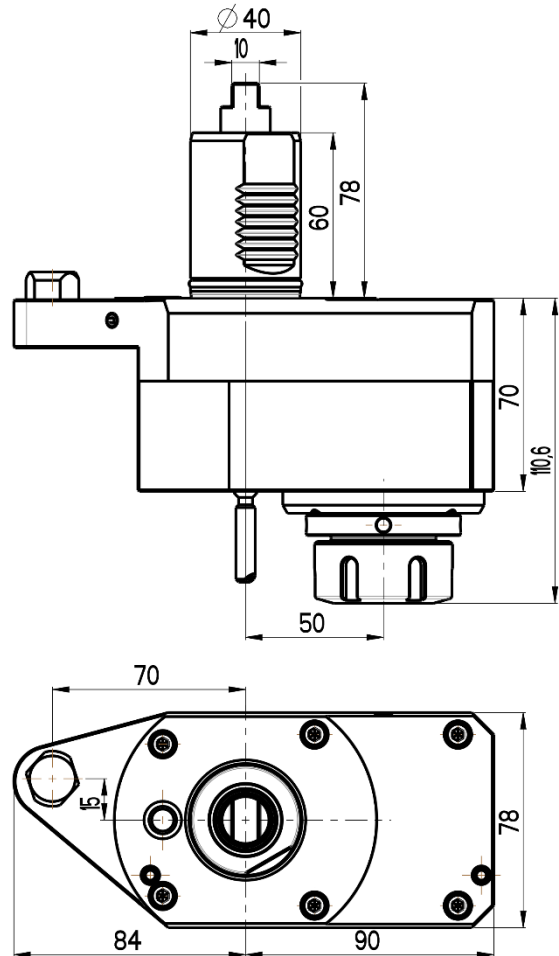

OFFSET STRAIGHT LIVE TOOL HOLDER

MAZAK QTN200/250

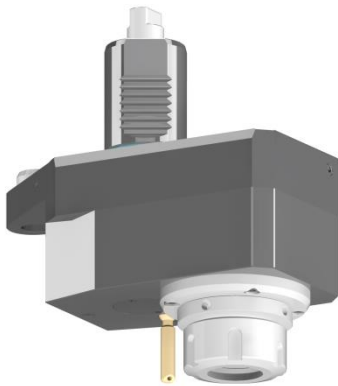

RGX1-40/321-32/1.1-50MZ2(2:1)

Max. speed: 3000 rpm

Max. torque: 80 Nm

Collet: ER32

Direction of rotation:

Ratio: 2:1

Cooling: external (internal cooling available)

Accessories

Nut : Clamping wrench type E 32

Spindle: Hook wrench DIN 1810B 52-55

