

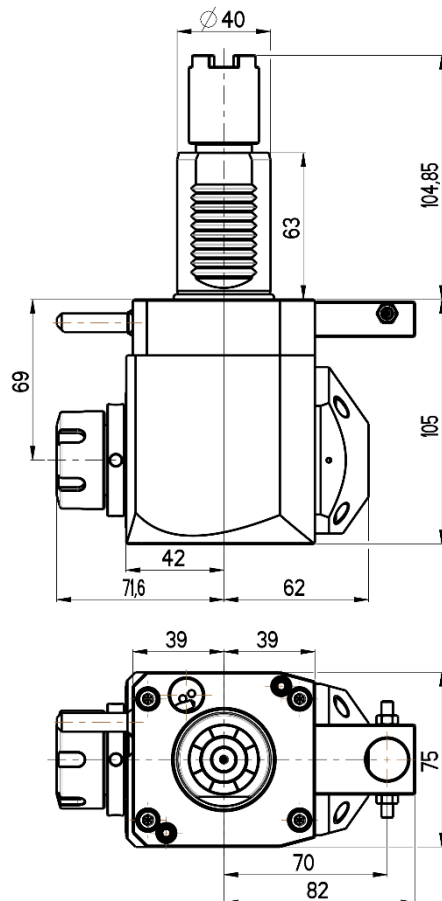

# ANGULAR LIVE TOOL HOLDER

## VDI 40 / STEPPED

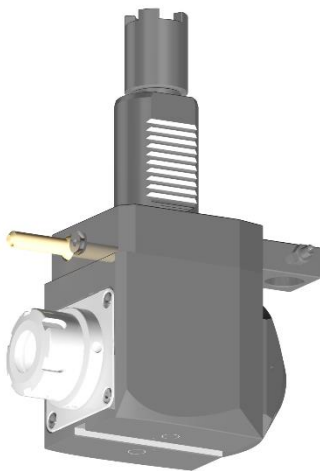

**RGX1-40/251-25/2.2-69A**

**Max. speed:** 6000 rpm

**Max. torque:** 50 Nm

**Collet:** ER25

**Direction of rotation:**

**Ratio:** 1:1

**Cooling:** external & internal

**Max. pressure:** 20 bar

### Accessories

**Nut :** Clamping wrench type E 25

**Spindle:** Hook wrench DIN 1810B 45-50

