

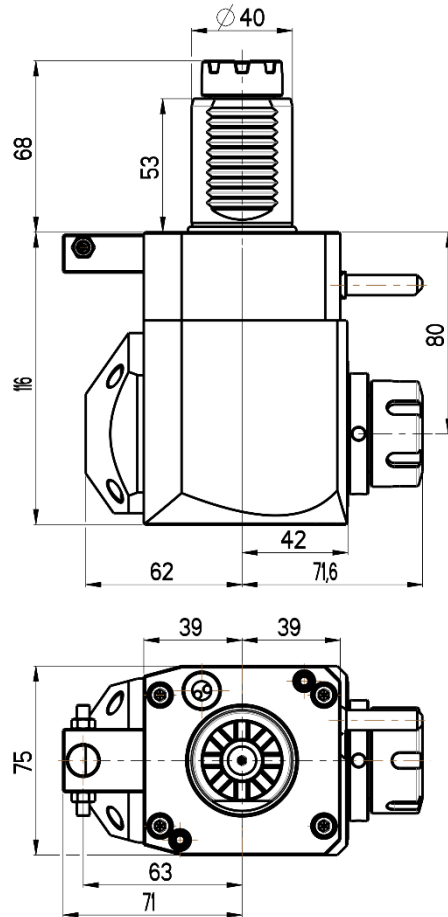

# ANGULAR LIVE TOOL HOLDER

VDI 40 / TOEM 200

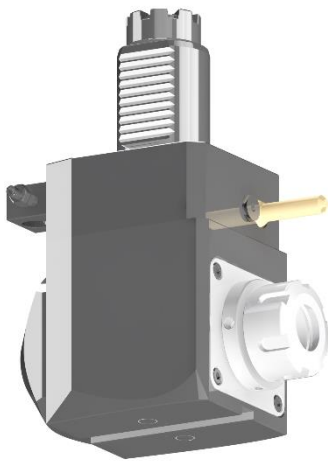

**RGX1-40/241-25/2.1-80**

**Max. speed:** 6000 rpm

**Max. torque:** 50 Nm

**Collet:** ER25

**Direction of rotation:**

**Ratio:** 1:1

**Cooling:** external & internal

**Max. pressure:** 20 bar

## Accessories

**Nut :** Clamping wrench type E 25

**Spindle:** Hook wrench DIN 1810B 45-50

