

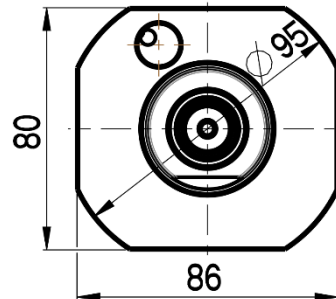

# STRAIGHT LIVE TOOL HOLDER

VDI 40 / DIN 5482

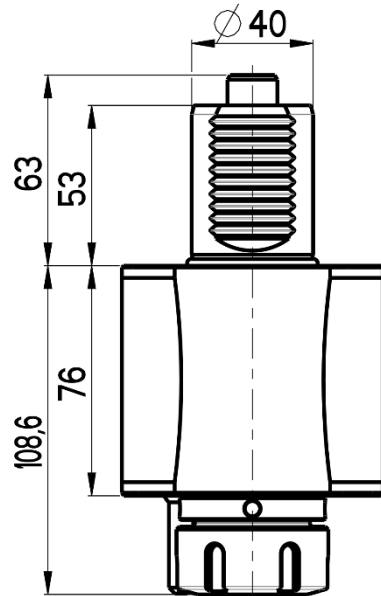
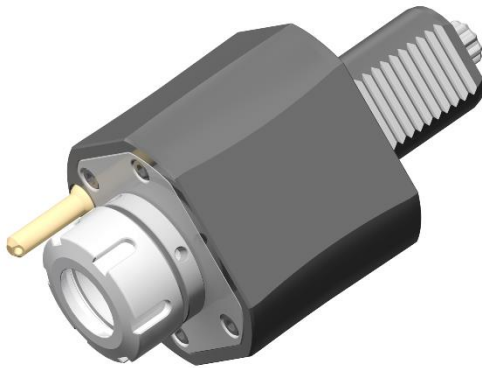

**RGX1-40/111-32/1**

**Max. speed:** 6000 rpm

**Max. torque:** 50 Nm

**Collet:** ER32

**Direction of rotation:**

**Ratio:** 1:1

**Cooling:** external (internal cooling available)

### Accessories

**Nut :** Clamping wrench type E 32



**Spindle:** Hook wrench DIN 1810B 45-50

