

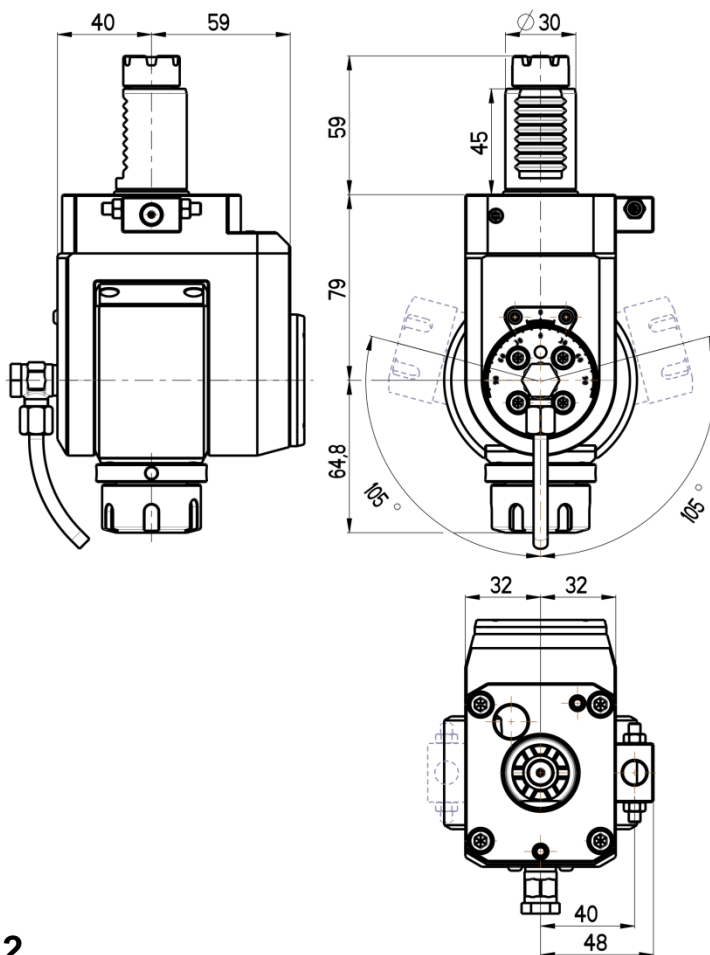

VARIABLE ANGLE LIVE TOOL HOLDER

VDI 30 / TOEM 160



RGX1-30/541-25/1.2

Max. speed: 6000 rpm

Max. torque: 16 Nm

Collet: ER25

Direction of rotation: ↻ ↻

Ratio: 1:1

Cooling: external (internal cooling available)

Accessories

Nut : Clamping wrench type E 25



Spindle: Hook wrench DIN 1810B 40-42

