

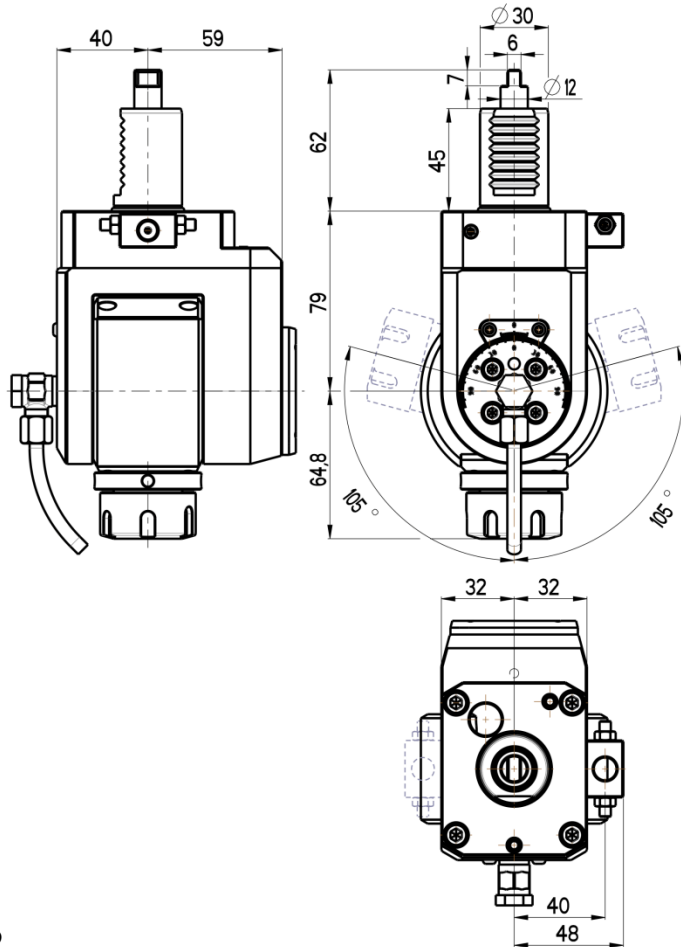

# VARIABLE ANGLE LIVE TOOL HOLDER

VDI 30 / DIN 1809

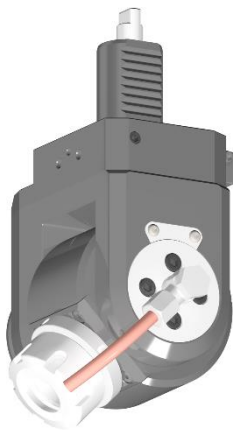

**RGX1-30/521-25/1.2**

**Max. speed:** 6000 rpm

**Max. torque:** 16 Nm

**Collet:** ER25

**Direction of rotation:** ↻ ↻

**Ratio:** 1:1

**Cooling:** external (internal cooling available)

### Accessories

**Nut :** Clamping wrench type E 25



**Spindle:** Hook wrench DIN 1810B 40-42

