

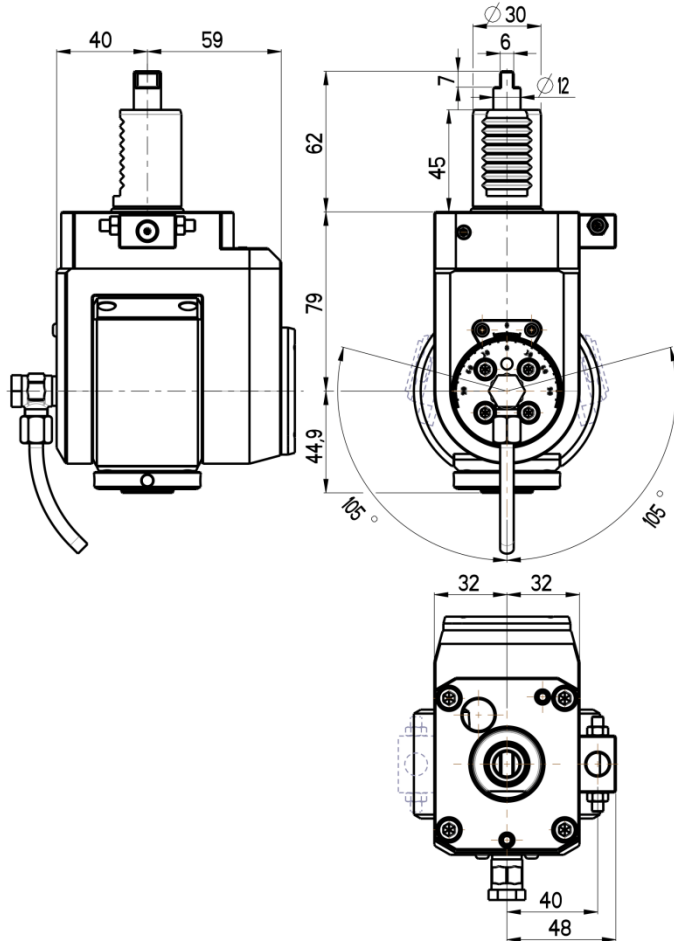

VARIABLE ANGLE LIVE TOOL HOLDER

VDI 30 / DIN 1809

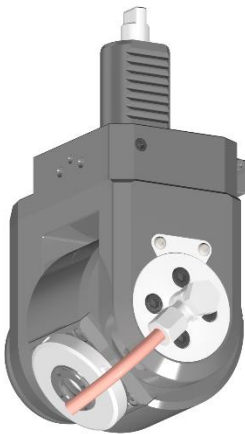

RGX1-30/521-16/1.2

Max. speed: 6000 rpm

Max. torque: 16 Nm

Collet: ER16

Direction of rotation: ↻ ↻

Ratio: 1:1

Cooling: external (internal cooling available)

Accessories

Nut: Caliper pin wrench

Spindle: Spanner 28