

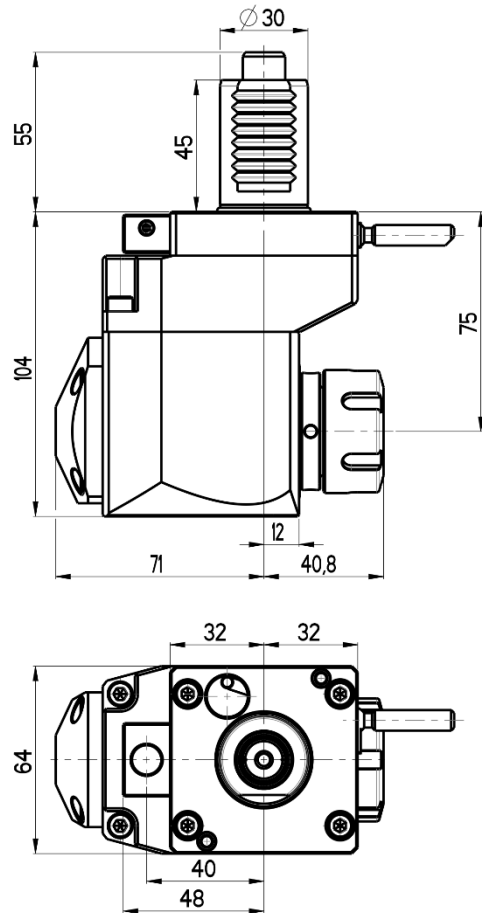

OFFSET ANGULAR LIVE TOOL HOLDER

VDI 30 / DIN 5482

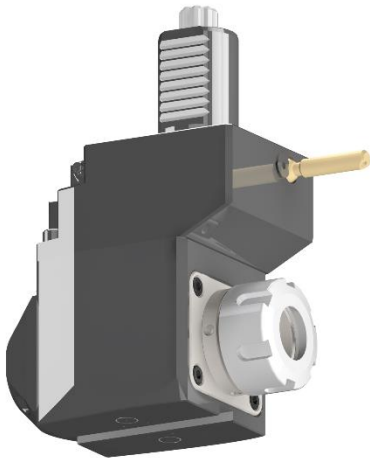

RGX1-30/411-25/2.1-75

Max. speed: 6000 rpm

Max. torque: 28 Nm

Collet: ER25

Direction of rotation:

Ratio: 1:1

Cooling: external & internal

Max. pressure: 20 bar

Accessories

Nut : Clamping wrench type E 25

Spindle: Hook wrench DIN 1810B 40-42

