

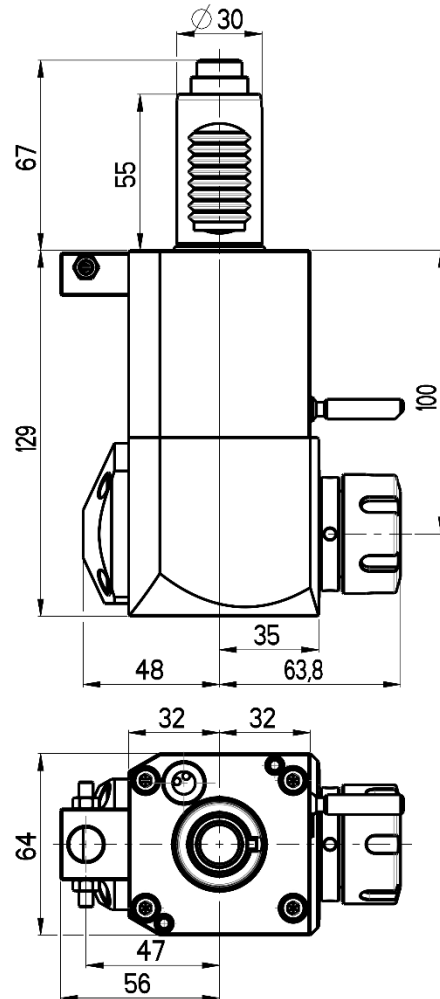

# ANGULAR LIVE TOOL HOLDER

VDI 30 / DIN 5480

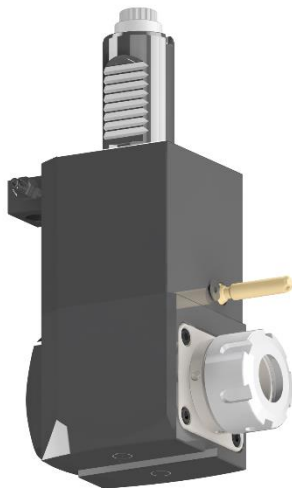

**RGX1-30/231-25/1.1-100**

**Max. speed:** 6000 rpm

**Max. torque:** 28 Nm

**Collet:** ER25

**Direction of rotation:**

**Ratio:** 1:1

**Cooling:** external (internal cooling available)

### Accessories

**Nut :** Clamping wrench type E 25



**Spindle:** Hook wrench DIN 1810B 40-42

