

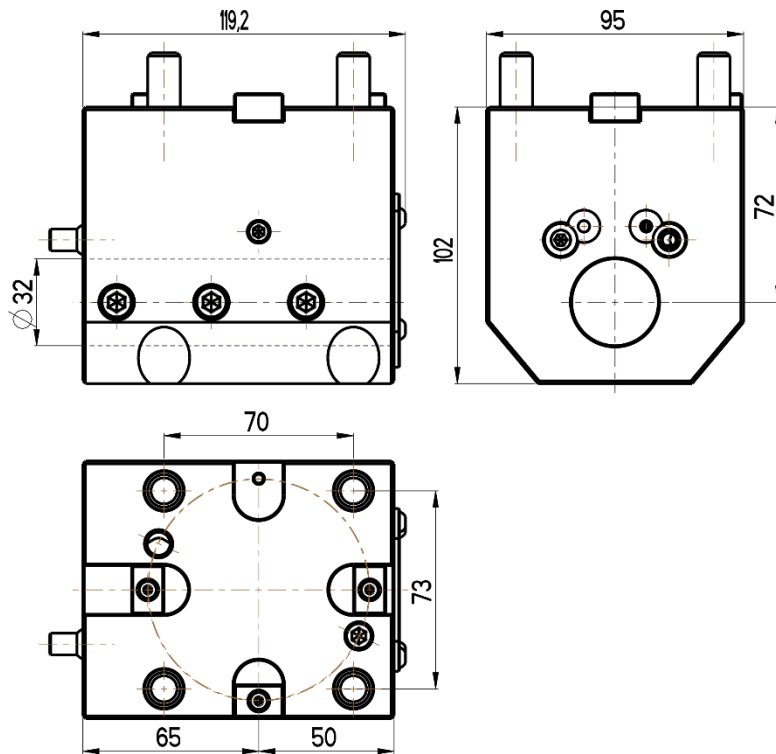

**ID cutting holder**  
**DOOSAN TURRET**  
**BMT 65**

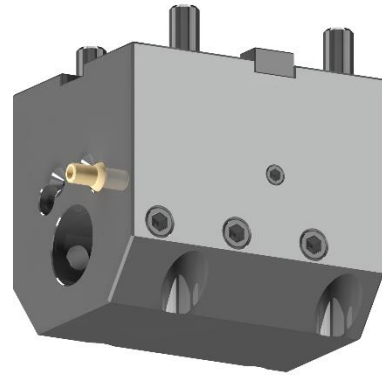

**RGX ID-65x32x72(DO)**

**Cooling:** *external & internal*