

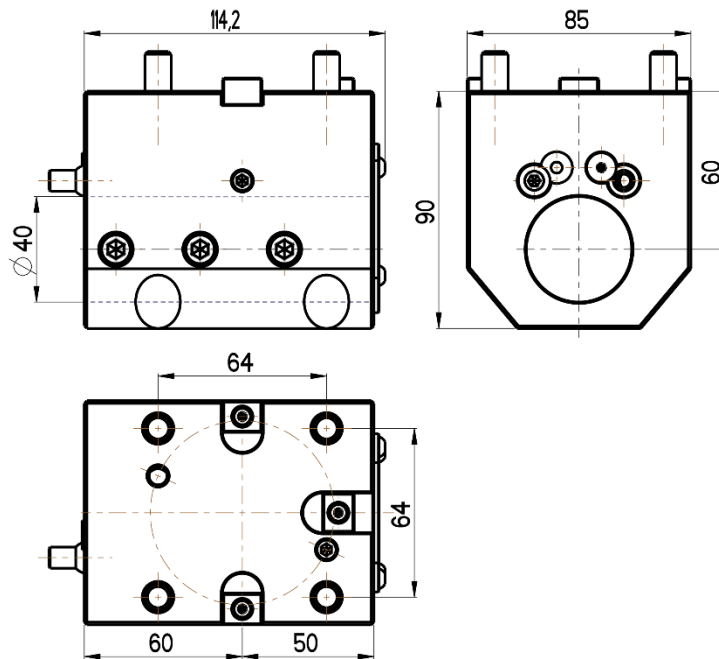

ID cutting holder
DOOSAN TURRET
BMT 55

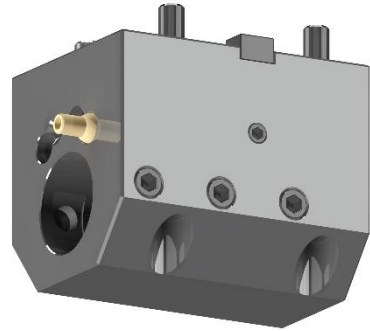

RGX ID-55x40x60(DO)

Cooling: *external & internal*