

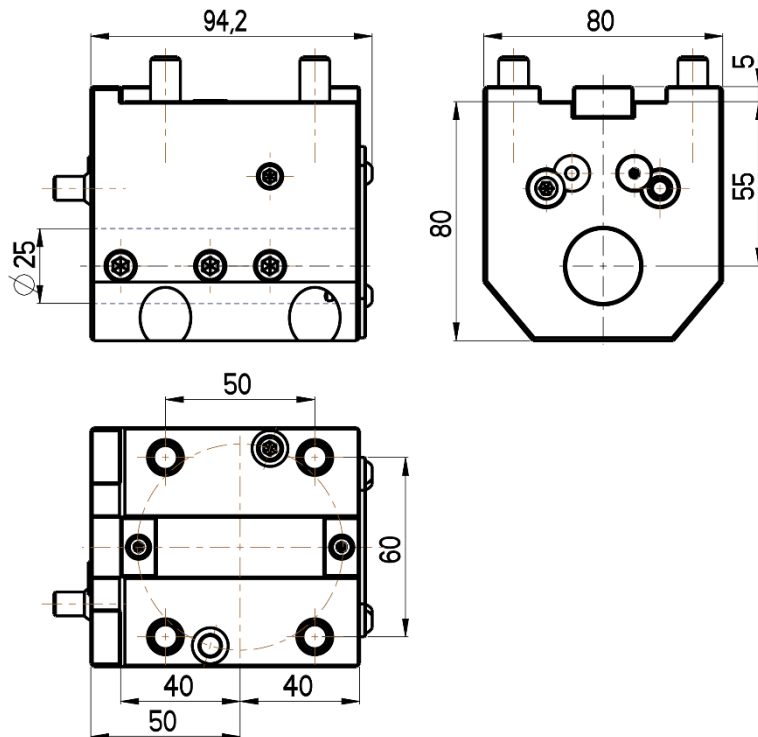

ID cutting holder
Nakamura-Tome TURRET
BMT 55

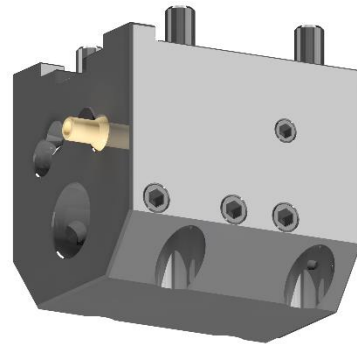

RGX ID-55x25x55S(NT)

Cooling: external & internal