

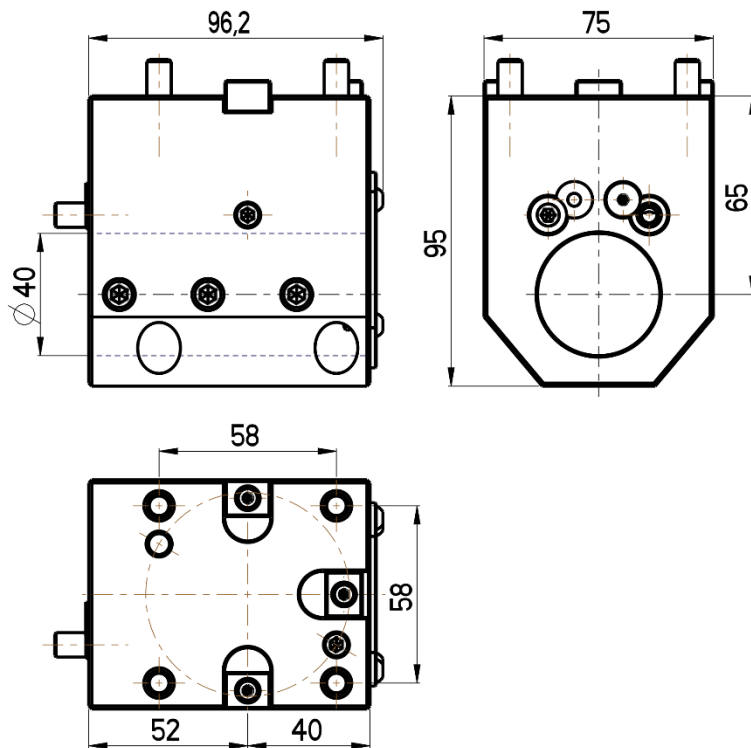

ID cutting holder
DOOSAN TURRET
BMT 45

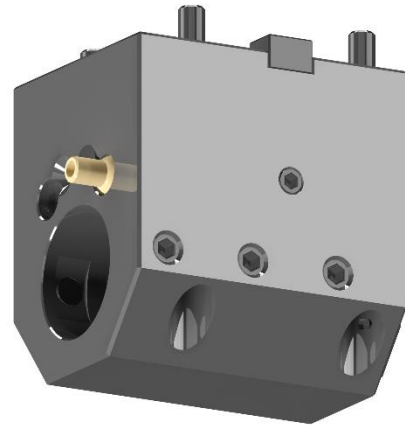

RGX ID-45x40x65(DO)

Cooling: *external & internal*