

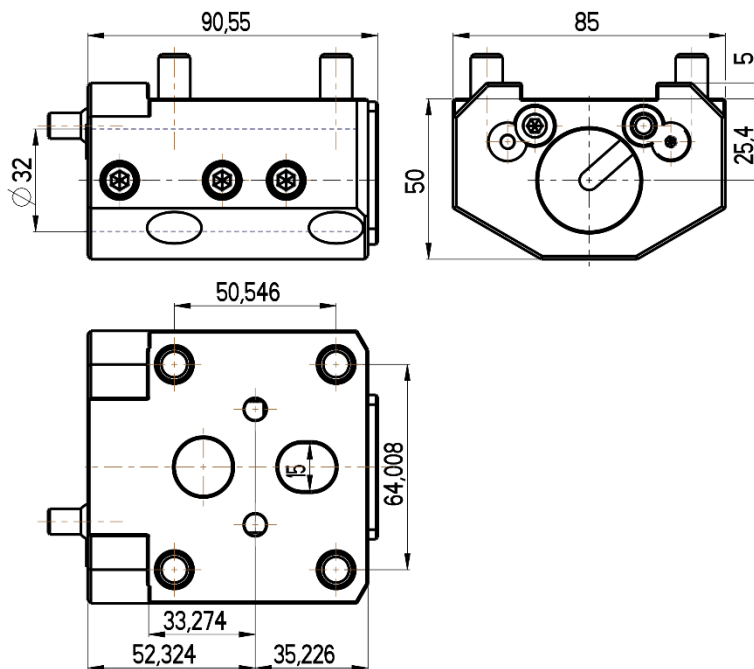

ID cutting holder

HAAAS TURRET

Hybrid VB24

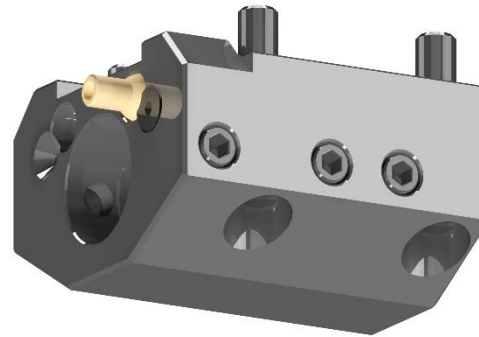

RGX ID-32x25,4(HA)

Cooling: external & internal