

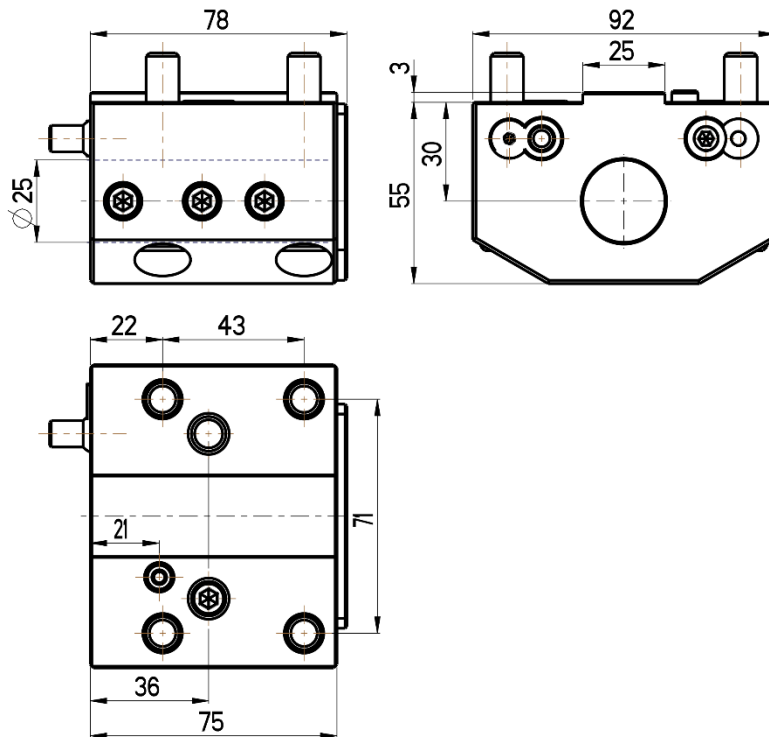

ID cutting holder
GILDEMEISTER TURRET

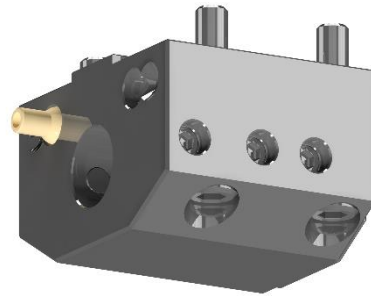

RGX ID-25x25x30(GI)

Cooling: *external & internal*