

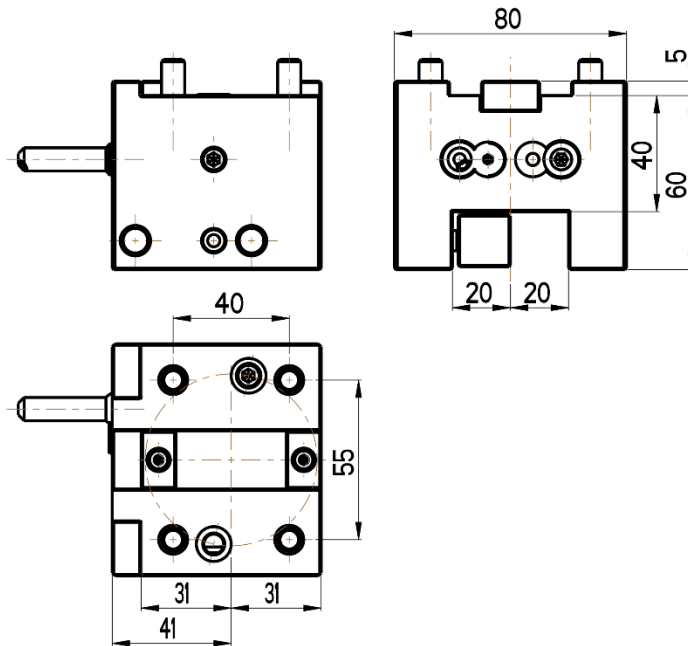

Face cutting holder
Nakamura-Tome TURRET
BMT 44

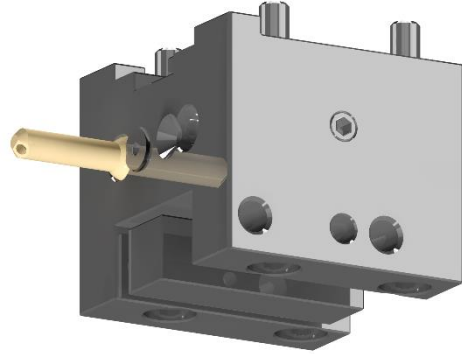

RGX F-44x20x60(NT)

Cooling: *external*