

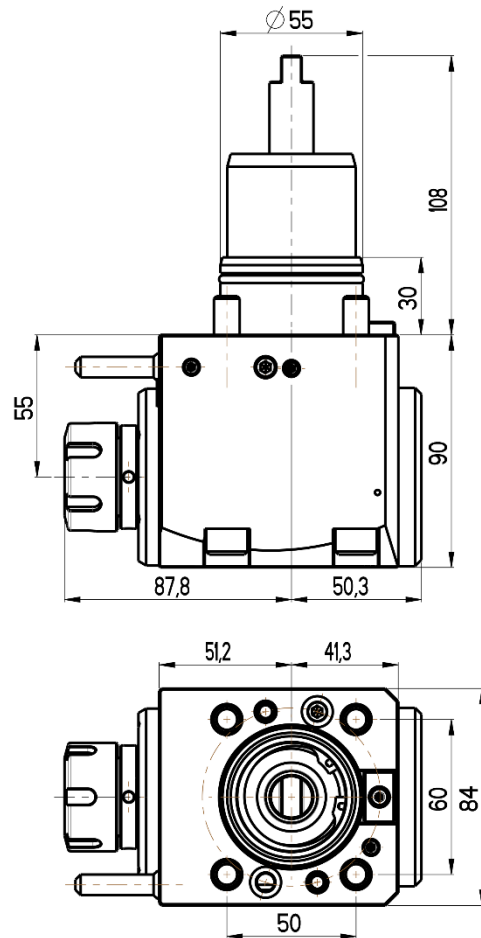

ANGULAR LIVE TOOL HOLDER

NAKAMURA-TOME

BMT 55 TURRET

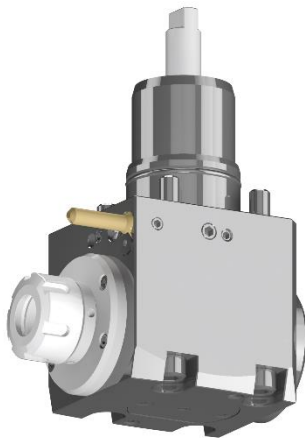

RGX2-55/201-25/1.3-55(NT)

Max. speed: 6000 rpm

Max. torque: 28 Nm

Collet: ER25

Direction of rotation:

Ratio: 1:1

Cooling: external (internal cooling available)

Accessories

Nut : Clamping wrench type E 25

Spindle: Hook wrench DIN 1810B 40-42

