

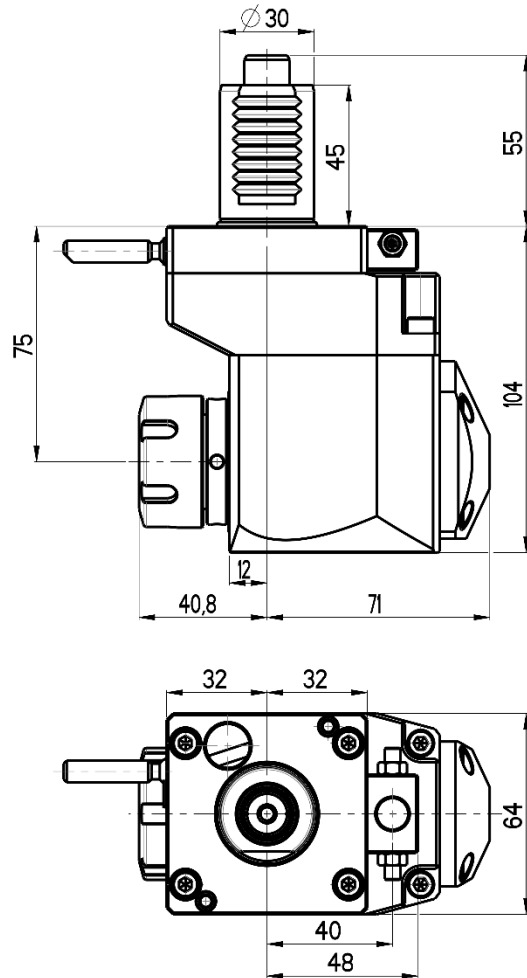

OFFSET ANGULAR LIVE TOOL HOLDER

VDI 30 / DIN 5482

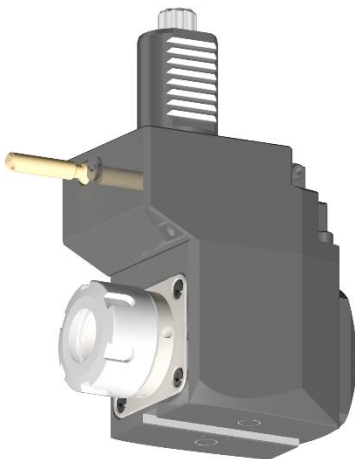

RGX1-30/411-25/1.2-75

Max. speed: 6000 rpm

Max. torque: 28 Nm

Collet: ER25

Direction of rotation:

Ratio: 1:1

Cooling: external (internal cooling available)

Accessories

Nut : Clamping wrench type E 25



Spindle: Hook wrench DIN 1810B 40-42

