

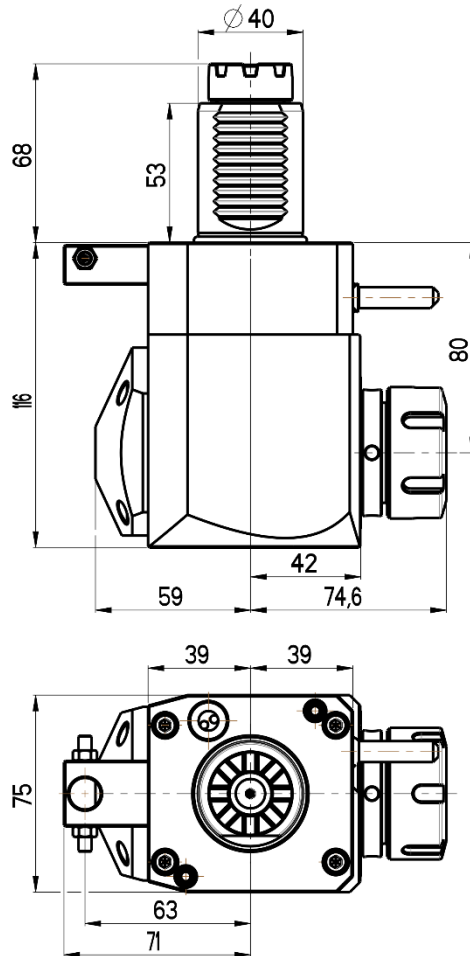

ANGULAR LIVE TOOL HOLDER

VDI 40 / TOEM 200

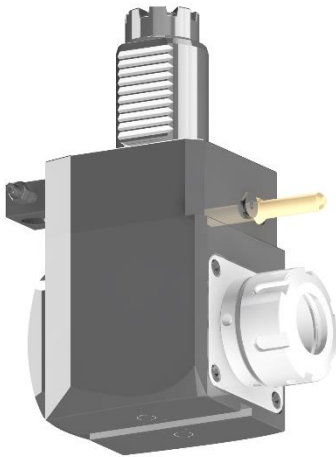

RGX1-40/241-32/1.1-80

Max. speed: 6000 rpm

Max. torque: 50 Nm

Collet: ER32

Direction of rotation:

Ratio: 1:1

Cooling: external (internal cooling available)

Accessories

Nut : Clamping wrench type E 32

Spindle: Hook wrench DIN 1810B 45-50

