

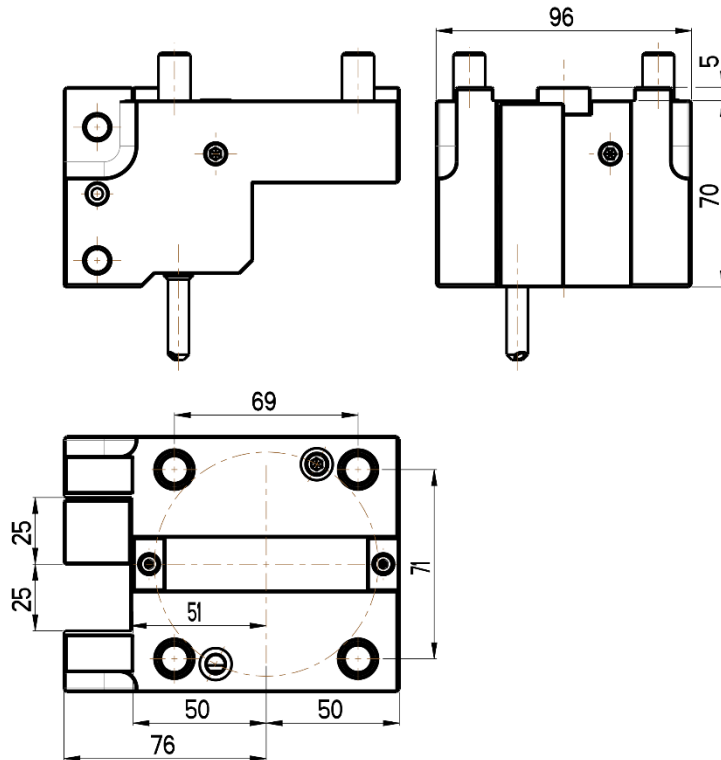

OD cutting holder
Nakamura-Tome TURRET
BMT 65

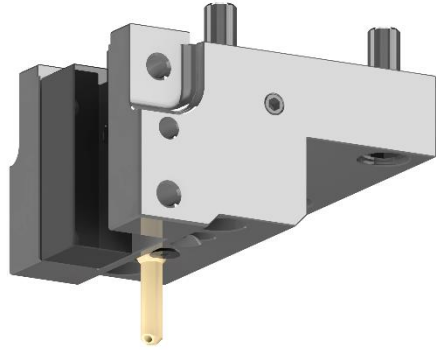

RGX OD-65x25x70(NT)

Cooling: *external*