

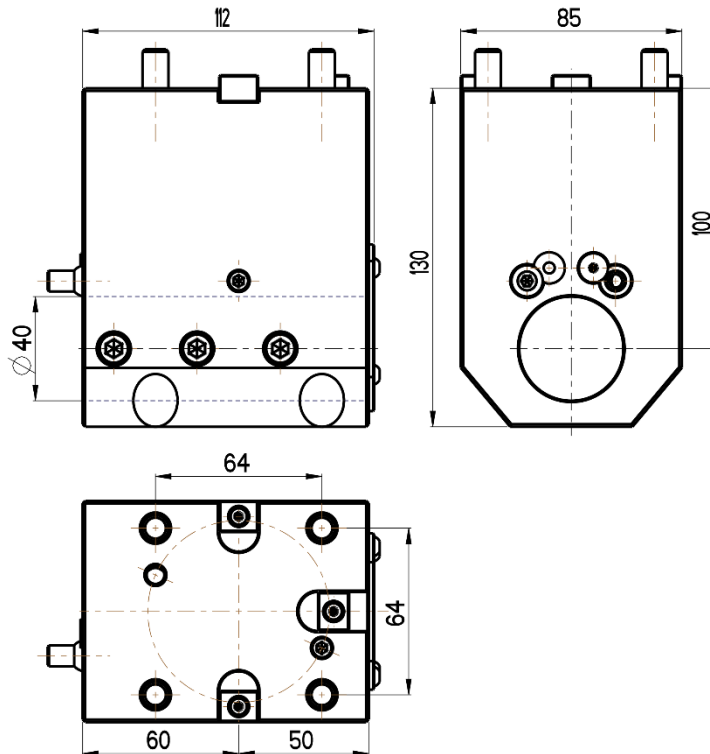

**ID cutting holder**  
**DOOSAN TURRET**  
**BMT 55**

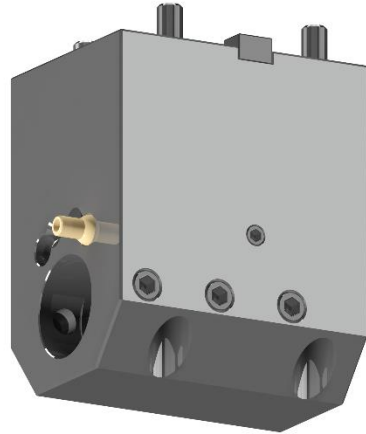

**RGX ID-55x40x100(DO)**

**Cooling:** external & internal